

GRUNDFOS A WIDE RANGE OF QUALITY PUMPS



BE > THINK > INNOVATE >

GRUNDFOS 



A global business

With over 10,000 employees and annual production of some 8 million pump units a year, Grundfos is one of the world's leading pump manufacturers. More than 50 companies right across all the continents of the globe help to bring pumps to every corner of the world, from supplying drinking water to Antarctic expeditions, irrigation of Dutch tulips, groundwater monitoring beneath waste heaps in Germany, to air-conditioning in Egyptian hotels.

Efficient, sustainable products

Grundfos is constantly striving to make its products more userfriendly and reliable – and also energy saving and efficient, so that both users and the environment benefit from their improvements.

Grundfos pumps are equipped with ultramodern electronics, allowing them to regulate their output according to current needs. This not only ensures convenience for the user, but also saves a great deal of energy.

Research and development

In order to maintain its leading position, Grundfos constantly places a great deal of emphasis on customer-oriented research and development; customers are



consulted when new products are developed or when established products are improved.

Research and development make use of the latest technology within the pump industry, collaborating with universities and higher education institutions in search of new and better solutions for the design and function of the products.

Corporate values

The Grundfos Group is based on values such as sustainability, openness, trustworthiness, responsibility, and also on partnership with clients, suppliers and the whole of society around us, with a focus on humanity that concerns our own employees as well as the many millions who benefit from water that is procured, utilised and removed as wastewater with the help of Grundfos pumps.

Pumps for all purposes

No matter for which purpose an efficient and energy-saving pump solution is required, Grundfos offers a high-quality solution.



Heating and hot water service systems

Circulator pumps for circulation of hot water in central and district heating systems and circulation in domestic hot water service systems.



Cooling and air-conditioning systems

Circulator pumps for circulation of cold water and other liquids in cooling and air-conditioning systems.



Industrial applications

A wide range of multistage pumps for the transfer of water, cooling lubricants and other liquids in industrial and process systems.



Pressure boosting and liquid transfer

Vertical and horizontal, centrifugal pumps and pressure boosting systems for liquid transfer and boosting of hot and cold water.



Groundwater supply

Submersible pumps for groundwater supply, irrigation and groundwater lowering.

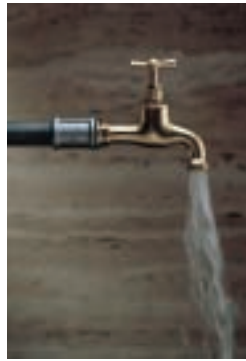

Domestic water supply

Submersible pumps, jet pumps, multi-stage centrifugal pumps and compact systems for water supply in homes, gardens and hobby applications.

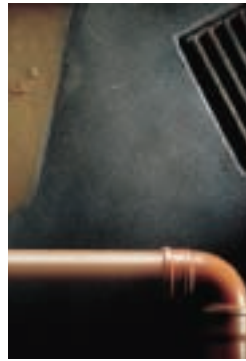

Sewage and wastewater

Drainage, effluent and sewage pumps for a wide range of applications in building services as well as transfer of raw sewage in municipal sewage systems.



Environmental applications

Purpose-built submersible pumps for remedial pumping of contaminated groundwater and for groundwater sampling for water quality analyses.



Dosing

Dosing pumps for wastewater treatment systems, swimming pools and industry.

PRODUCT AND APPLICATION OVERVIEW

Product name	Page	Product type	Application									
			Heating and hot water service systems	Cooling and air-conditioning systems	Industrial applications	Pressure boosting and liquid transfer	Groundwater supply	Domestic water supply	Sewage and wastewater	Environmental applications	Dosing	
GRUNDFOS ALPHA	8	Circulator pumps, canned-rotor type	●	●								
GRUNDFOS COMFORT	8	Circulator pumps, canned-rotor type	●	●								
UPS Series 100	8	Circulator pumps, canned-rotor type	●	●								
UPS Series 200	8	Circulator pumps, canned-rotor type	●	●								
UPE Series 2000	9	Circulator pumps, canned-rotor type	●									
TP	9	Circulator pumps, close-coupled type	●	●								
LM, LP, CLM	9	Single-stage centrifugal pumps	●	●	●	●						
TPE Series 2000	10	Single-stage centrifugal pumps	●	●								
TPE, LME, LPE, CLME	10	Single-stage centrifugal pumps	●	●	●	●						
Delta Control 2000	11	Controllers	●	●								
NM, NP, DNM, DNP	11	Single-stage standard pumps	●	●	●	●						
NB, NBG	12	Single-stage standard pumps	●	●	●	●						
NK, NKG	12	Single-stage standard pumps	●	●	●	●						
NME, NPE, DNME, DNPE	12	Single-stage standard pumps	●	●	●	●						
NBE	13	Single-stage standard pumps	●	●	●	●						
NKE	13	Single-stage standard pumps	●	●	●	●						
SPK, CHK, MTH, CRK, MTR, MTA	13	Multistage centrifugal pumps			●							
SPKE, CRKE	14	Multistage centrifugal pumps			●							
DME, DMS, DMM	14	Dosing pumps, diaphragm type			●							●
WPU	15	Whirlpool pump units			●							
CHI, CHIU	15	Multistage centrifugal pumps		●	●	●					●	
CHIE	15	Multistage centrifugal pumps		●	●	●					●	

PRODUCT AND APPLICATION OVERVIEW

Product name	Page	Product type	Application								
			Heating and hot water service systems	Cooling and air-conditioning systems	Industrial applications	Pressure boosting and liquid transfer	Groundwater supply	Domestic water supply	Sewage and wastewater	Environmental applications	Dosing
CR, CRI, CRN	16	Multistage centrifugal pumps		●	●	●		●		●	
CRT	16	Multistage centrifugal pumps			●	●				●	
CV, CPV, CPH	17	Multistage centrifugal pumps		●	●	●					
CRE, CRIE, CRNE	17	Multistage centrifugal pumps		●	●	●		●		●	
Hydro 2000, Hydro 1000	18	Pressure boosting systems			●	●		●			
Control 2000	18	Controllers			●	●					
BM, BMB	18	Booster modules			●	●					
BMQ, BMQE-NE	19	Booster modules			●	●					
BME, BMET	19	High-pressure booster modules			●	●					
SQ, SQE	19	3" submersible pumps					●	●			
SP, SP-G	20	4"-6"-8"-10"-12" submersible pumps					●	●			
SQE-NE, SP-NE, MP 1	21	Environmental pumps								●	
JP	22	Self-priming jet pumps						●			
CH, CHN	22	Multistage centrifugal pumps			●	●		●			
CHV	23	Multistage centrifugal pumps			●	●		●			
CHV booster	23	Pressure boosting systems			●	●		●			
MQ	23	Multistage centrifugal pumps				●		●			
Tanks	24	Diaphragm and bladder tanks			●			●			
KP, AP - stainless steel	24	Drainage pumps								●	
AP, APG - cast iron	24	Effluent and sewage pumps								●	
APB	25	Contractor pumps								●	
Lifting stations	25	Complete pumping stations								●	
Grundfos Sarlin pumps	25	Effluent and sewage pumps								●	



GRUNDFOS ALPHA UPS, UP Series 100

Circulator pumps, canned-rotor type

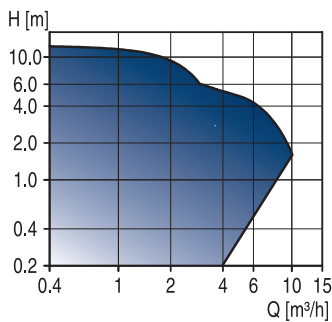

Technical data

Flow, Q:	max. 10 m³/h
Head, H:	max. 12 m
Liquid temp.:	- 25°C to +110°C
Operat. pres.:	max. 10 bar

Applications

- Circulation of hot or cold water in
- Heating systems
 - Domestic hot water systems
 - Cooling and air-conditioning systems

Features and benefits

- Maintenance-free
- Low-noise
- Low-energy
- Wide range

Optional

- Automatic performance adjustment
- Simple installation - external plug for electrical connection
- Single-speed or 2- or 3-speed performance adjustment
- Twin-head versions



GRUNDFOS COMFORT UP-N, UP-B Series 100

Circulator pumps, canned-rotor type

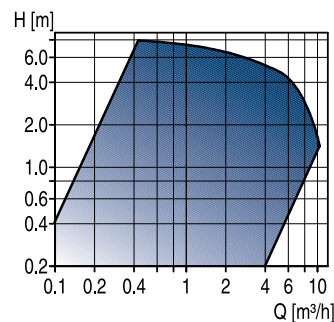

Technical data

Flow, Q:	max. 10 m³/h
Head, H:	max. 8 m
Liquid temp.:	- 25°C to +110°C
Operat. pres.:	max. 10 bar

Applications

- Circulation of hot or cold water in
- Domestic hot water recirculation
 - Heating systems
 - Domestic hot water systems
 - Cooling and air-conditioning systems

Features and benefits

- Maintenance-free
- Low-noise
- Low-energy
- Wide range
- Corrosion-resistant stainless steel, brass or bronze pump housing

Optional

- 24-hour timer
- Adjustable thermostat



UPS Series 200

Circulator pumps, canned-rotor type

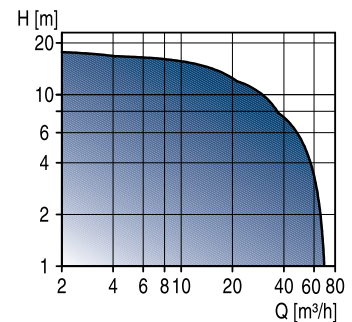

Technical data

Flow, Q:	max. 70 m³/h
Head, H:	max. 18 m
Liquid temp.:	- 10°C to +120°C
Operat. pres.:	max. 10 bar

Applications

- Circulation of hot or cold water in
- Heating systems
 - Domestic hot water systems
 - Cooling and air-conditioning systems

Features and benefits

- Maintenance-free
- Built-in thermal switch
- Low-noise
- Low-energy
- Single-phase with built-in protection module
- Wide range

Optional

- Protection module
- Relay module with fault signal or operating output
- Bronze pump housing
- Twin-head versions
- Communication via GENibus or LON



UPE Series 2000

Circulator pumps, canned-rotor type - electronically controlled

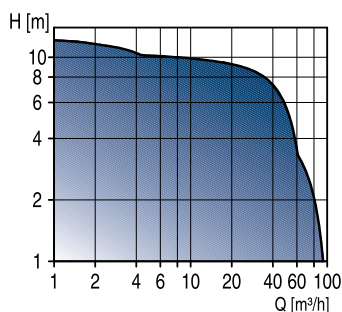

Technical data

Flow, Q:	max. 90 m ³ /h
Head, H:	max. 12 m
Liquid temp.:	+15°C to +110°C
Operat. pres.:	max. 10 bar

Applications

Circulation of hot water in

- Heating systems in blocks of flats, schools, hospitals, hotels, industry etc.

Features and benefits

- Low-noise
- Low-energy
- Wide range
- Automatic performance adjustment
- Simple installation - no extra equipment or fittings required
- Safe selection

Optional

- Bronze pump housing
- Twin-head versions
- Wireless remote control, R100
- Communication via GENibus or LON



TP

Circulator pumps, close-coupled type

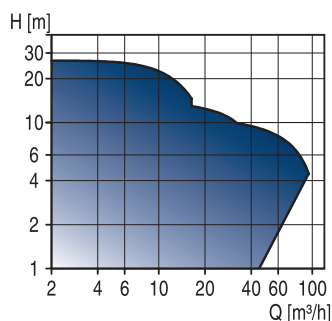

Technical data

Flow, Q:	max. 95 m ³ /h
Head, H:	max. 27 m
Liquid temp.:	- 15°C to +140°C
Operat. pres.:	max. 16 bar

Applications

Circulation of hot or cold water in

- Heating systems
- District heating plants
- Local heating plants
- Domestic hot water systems
- Cooling and air-conditioning systems

Features and benefits

- Compact design
- Wide range
- Standard motor
- Service-friendly
- Various types of shaft seals depending on liquid, temperature and pressure

Optional

- Bronze pump housing
- Twin-head versions



LM, LP, CLM

Single-stage centrifugal pumps

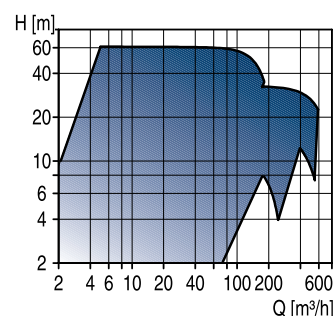

Technical data

Flow, Q:	max. 600 m ³ /h
Head, H:	max. 60 m
Liquid temp.:	- 40°C to +140°C
Operat. pres.:	max. 20 bar

Applications

The pumps are suitable for liquid transfer in

- District heating plants
- Cooling and air-conditioning systems
- Industrial plants

Features and benefits

- Adaptable to any application and performance
- DIN 24 960 shaft seal
- Wide range
- Standard motor
- Service-friendly

Optional

- Various types of shaft seals depending on liquid, temperature and pressure
- Twin-head versions
- Bronze impeller (CLM only)



TPE Series 2000

Single-stage, centrifugal pumps - electronically controlled

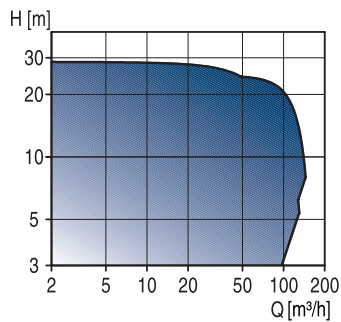

Technical data

Flow, Q:	max. 130 m ³ /h
Head, H:	max. 28 m
Liquid temp.:	- 25°C to +140°C
Operat. pres.:	max. 16 bar

Applications

- Circulation of hot or cold water in
- Heating systems
 - Domestic hot water systems
 - Cooling and air-conditioning systems

Features and benefits

- Low-energy
- Adaptation to existing operating conditions
- Simple installation

Optional

- Parallel operation
- Wireless remote control, R100
- Communication via GENibus or LON



LME, LPE, CLME, TPE

Single-stage, centrifugal pumps - electronically controlled

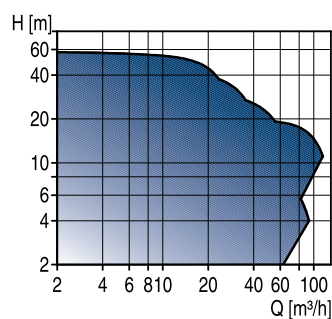

Technical data

Flow, Q:	max. 160 m ³ /h
Head, H:	max. 60 m
Liquid temp.:	- 25°C to +140°C
Operat. pres.:	max. 16 bar

Applications

- The pumps are suitable for liquid transfer in
- District heating plants
 - Cooling and air-conditioning systems
 - Industrial plants

Features and benefits

- Low-energy
- Adaptation to existing operating conditions
- Simple installation
- Many control facilities
- Wireless remote control, R100
- Communication via GENibus or LON



R100

Wireless remote control

Applications

- All pumps designed for wireless communication

Features and benefits

- Simple and quick installation of the pump
- Reading out of various operating and fault signals
- Printing out of status information



PMU 2000, PCU 2000

Pump controllers

Applications

PMU 2000

- Parallel connection of up to eight pumps
- Central reading out of various status information

PCU 2000

- Fault indication for each pump
- External setpoint influence
- Start/stop of system

Features and benefits

- Communication via BUS
- Simple and quick installation



Delta Control 2000

Pump controllers

Technical data

No. of pumps:	max. 4
Power output:	75 kW
Encl. class:	IP 54

Applications

- Delta Control 2000 are used for parallel connection of pumps in
- Heating systems
 - Cooling and air-conditioning systems

Features and benefits

- Complete control panel

Optional

- External communication



NM, NP, DNM, DNP

Single-stage standard pumps

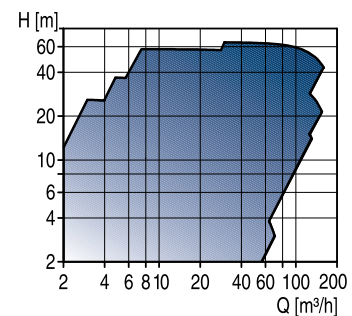

Technical data

Flow, Q:	max. 160 m ³ /h
Head, H:	max. 62 m
Liquid temp.:	- 25°C to +140°C
Operat. pres.:	max. 16 bar

Applications

The pumps are suitable for liquid transfer in

- Washing systems
- District heating plants
- Cooling and air-conditioning systems
- Industrial plants

Features and benefits

- Standard dimensions according to ISO or DIN standards
- Compact design
- Flexible pump range
- Standard motor
- Adaptable to any application and performance
- DIN 24 960 shaft seal

Optional

- Various types of shaft seal depending on liquid, temperature and pressure

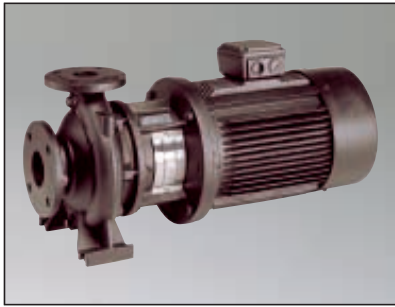

NB, NBG

Single-stage standard pumps

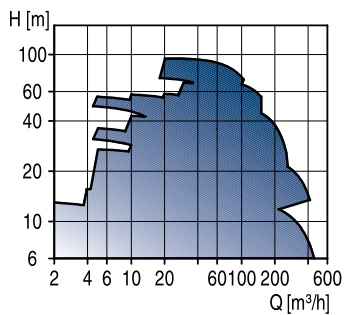

Technical data

Flow, Q:	max. 460 m ³ /h
Head, H:	max. 96 m
Liquid temp.:	- 10°C to +140°C
Operat. pres.:	max. 16 bar

Applications

The pumps are suitable for liquid transfer in

- District heating plants
- Heating systems for blocks of flats
- Air-conditioning systems
- Cooling systems
- Washdown systems
- Other industrial systems

Features and benefits

- Standard dimensions according to EN and ISO standards
- Compact design
- Flexible pump range
- Standard motor
- Adaptable to any application and performance
- DIN 24 960 shaft seal

Optional

- Various types of shaft seal depending on liquid, temperature and pressure
- Cast iron or bronze impeller

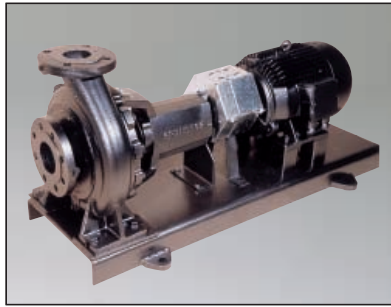

NK, NKG

Single-stage standard pumps

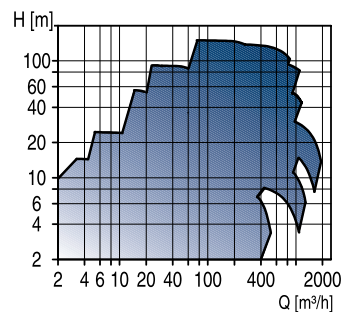

Technical data

Flow, Q:	max. 2000 m ³ /h
Head, H:	max. 150 m
Liquid temp.:	- 10°C to +140°C
Operat. pres.:	max. 16 bar

Applications

The pumps are suitable for liquid transfer in

- District heating
- Water supply
- Airconditioning
- Cooling plants
- Industry
- Fire fighting
- Environment engineering

Features and benefits

- Standard dimensions according to EN or ISO standards
- Wide range
- Robust design
- Heavy-duty
- Flexible motor range

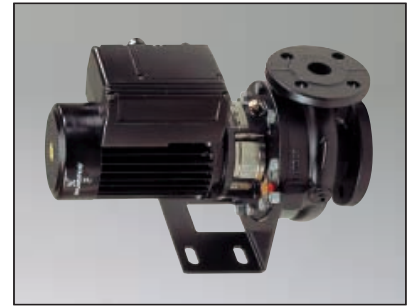

NME, NPE, DNME, DNPE

Single-stage standard pumps - electronically controlled

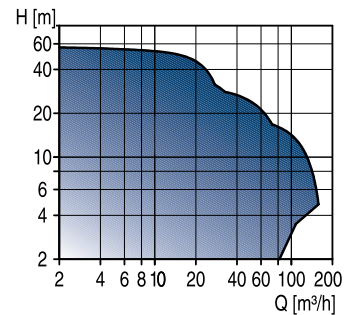

Technical data

Flow, Q:	max. 157 m ³ /h
Head, H:	max. 57 m
Liquid temp.:	- 25°C to +140°C
Operat. pres.:	max. 16 bar

Applications

The pumps are suitable for liquid transfer in

- Washing systems
- District heating plants
- Cooling and air-conditioning systems
- Industrial plants

Features and benefits

- Standard dimensions according to ISO or DIN standards
- Compact design
- Flexible range
- Standard motor
- Adaptable to any application and performance
- Many control facilities
- DIN 24 960 shaft seal

Optional

- Various types of shaft seal depending on liquid, temperature and pressure
- Wireless remote control, R100



NBE

Single-stage standard pumps - electronically controlled

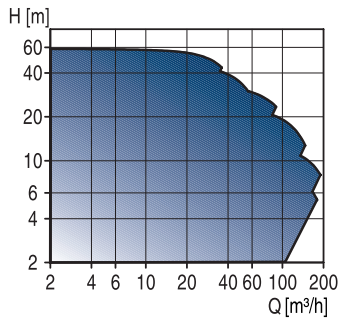

Technical data

Flow, Q:	max. 189 m ³ /h
Head, H:	max. 58 m
Liquid temp.:	- 10°C to +140°C
Operat. pres.:	max. 16 bar

Applications

The pumps are suitable for liquid transfer in

- Washing systems
- Water supply systems
- District heating plants
- Cooling and air-conditioning systems
- Industrial plants

Features and benefits

- Standard dimensions according to EN standards
- Compact design
- Adaptable to any application and performance
- DIN 24 960 shaft seal
- Many control facilities

Optional

- Various types of shaft seal depending on liquid, temperature and pressure
- Cast iron or bronze impeller
- Wireless remote control, R100



NKE

Single-stage standard pumps - electronically controlled

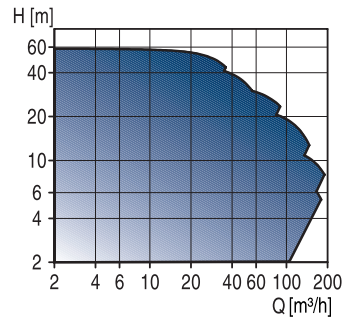

Technical data

Flow, Q:	max. 189 m ³ /h
Head, H:	max. 58 m
Liquid temp.:	- 40°C to +160°C
Operat. pres.:	max. 16 bar

Applications

The pumps are suitable for liquid transfer in

- Washing systems
- Water supply systems
- District heating plants
- Cooling and air-conditioning systems
- Industrial plants

Features and benefits

- Standard dimensions according to DIN standards
- Wide range
- Robust design
- Heavy-duty
- Many control facilities

Optional

- Wireless remote control, R100



SPK, CHK, MTH, CRK, MTR, MTA

Multistage centrifugal immersible pumps

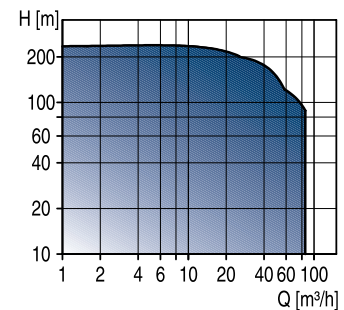

Technical data

Flow, Q:	max. 85 m ³ /h
Head, H:	max. 238 m
Liquid temp.:	- 20°C to +90°C
Operat. pres.:	max. 25 bar

Applications

The pumps are suitable for liquid transfer in

- Spark machine tools
- Grinding machines
- Machining centres
- Cooling units
- Industrial washing machines
- Filtering systems
- Lathes
- Swarf conveyors

Features and benefits

- Flexible installation length
- Wide range
- Reliable
- Service friendly
- Simple installation



SPKE, CRKE

Multistage centrifugal immersible pumps
- electronically controlled

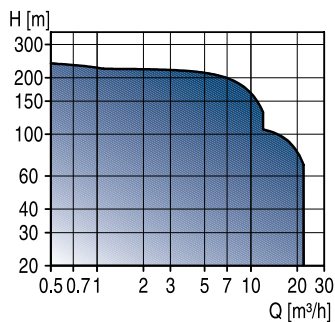

Technical data

Flow, Q:	max. 22 m ³ /h
Head, H:	max. 245 m
Liquid temp.:	- 10°C to +90°C
Operat. pres.:	max. 25 bar

Applications

The pumps are suitable for

- Boiler feeding
- Pumping of cooling lubricants
- Water treatment

Features and benefits

- Wide range
- Reliability
- Wireless remote control, R100



DME, DMS

Compact diaphragm dosing pumps

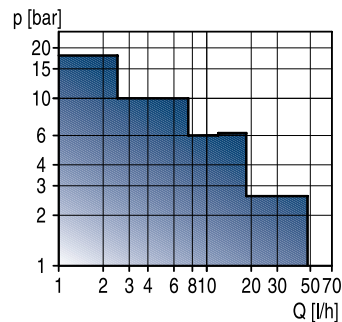

Technical data

Capacity, Q:	max. 48 l/h
Pressure, p:	max. 18 bar
Liquid temp.:	max. +50°C

Applications

Injection of chemicals in water and waste water treatment systems, washing systems, swimming pools and process plants

Features and benefits

- Precise capacity setting directly in ml or l
- Stepper or synchronous motor drive
- Full diaphragm control
- Stroke speed or -frequency capacity control
- Operation panel with display and one-touch buttons
- Front- or side-fitted operation panel
- Manual/pulse control
- Control panel lock
- 4-20 mA control
- Pulse-based batch control
- Timer-based batch control
- Anti-cavitation function
- Easy calibration function
- Fieldbus communication module (option)



DMM

Motor-driven diaphragm dosing pumps

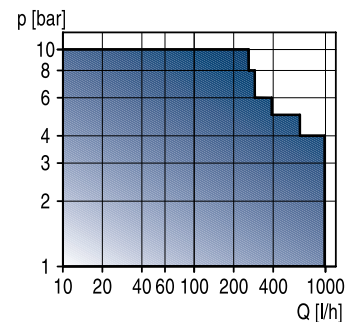

Technical data

Capacity, Q:	max. 990 l/h
Pressure, p:	max. 10 bar
Liquid temp.:	max. +50°C

Applications

Injection of chemicals in water and waste water treatment systems, washing systems, swimming pools and process plants

Features and benefits

- Sturdy design
- Stroke length capacity control
- Leakage-free
- Motor control option with display and one-touch buttons and following control options:
 - Pulse control
 - Pulse division/multiplication
 - Analog 0/4-20 mA control



WPU

Whirlpool pump units

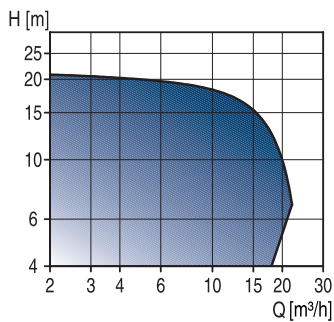

Technical data

Flow, Q:	max. 22 m³/h
Head, H:	max. 21 m
Liquid temp.:	0°C to +40°C
Operat. pres.:	max. 2.5 bar

Applications

The pumps are suitable for

- Spa and whirlpool baths
- Therapeutic baths

Features and benefits

- Wide operating range
- All-in-one, compact and robust design
- Programming and monitoring via PC
- Connection for external control panel
- Speed controlled motor provides advanced water pulsation
- Dry-running and thermal overload protection
- Excess heat from motor cooling directed to bath water

Optional

- Integrated heating unit
- Level sensor
- Control panels



CHI, CHIU

Multistage centrifugal pumps

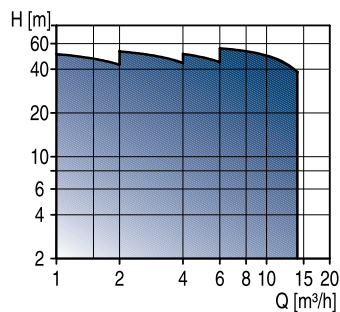

Technical data

Flow, Q:	max. 14 m³/h
Head, H:	max. 57 m
Liquid temp.:	-15°C to +110°C
Operat. pres.:	max. 10 bar

Applications

The pumps are suitable for liquid transfer in

- Water treatment
- Industrial washing and dishwashing machines
- Pressure boosting of process water
- Heating and cooling in industrial processes
- Air-conditioning
- Airwashing, moisturization, humidification (softened water)
- Water supply and pressure boosting (potable water, also slightly chlorinated)

Features and benefits

- Compact design
- Wide range
- Suitable for slightly aggressive liquids
- Low noise
- Leakage-free (CHIU only)



CHIE

Multistage centrifugal pumps - electronically controlled

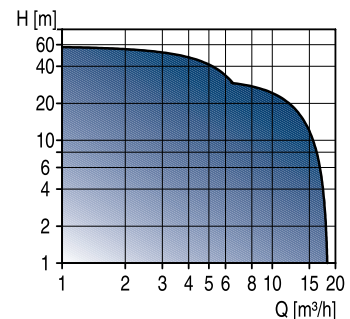

Technical data

Flow, Q:	max. 18 m³/h
Head, H:	max. 58 m
Liquid temp.:	-15°C to +110°C
Operat. pres.:	max. 10 bar

Applications

The pumps are suitable for liquid transfer in

- Cooling systems
- Industrial washing systems
- Aquafarms
- Fertilizer systems
- Dosing systems
- Industrial plants

Features and benefits

- Compact design
- Wide range
- Suitable for slightly aggressive liquids
- Many control facilities

Optional

- Wireless remote control, R100



CR, CRI, CRN

Multistage centrifugal pumps

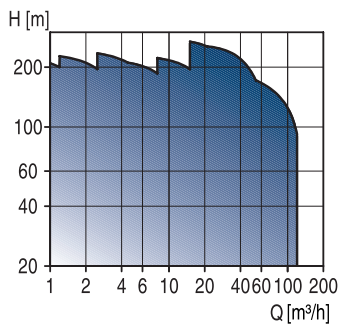

Technical data

Flow, Q:	max. 120 m ³ /h
Head, H:	max. 270 m
Liquid temp.:	- 40°C to +180°C
Operat. pres.:	max. 30 bar

Applications

The pumps are suitable for liquid transfer in

- Washing systems
- Cooling and air-conditioning systems
- Water supply systems
- Water treatment systems
- Fire fighting systems
- Industrial plants
- Boiler feeding systems

Features and benefits

- Reliability
- High efficiency
- Service-friendly
- Space-saving
- Suitable for slightly aggressive liquids

Optional

- Dry-running protection and motor protection via LiqTec



CR, CRN high pressure

Multistage centrifugal pumps

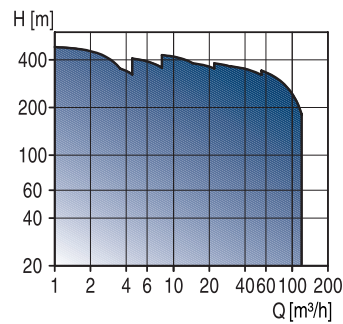

Technical data

Flow, Q:	max. 120 m ³ /h
Head, H:	max. 480 m
Liquid temp.:	- 30°C to +120°C
Operat. pres.:	max. 45 bar

Applications

The pumps are suitable for liquid transfer in

- Washing systems
- Water treatment systems
- Industrial plants
- Boiler feeding systems

Features and benefits

- Reliability
- High pressures
- Service-friendly
- Space-saving
- Suitable for slightly aggressive liquids
- Single pump solution enabling high pressure

Optional

- Dry-running protection and motor protection via LiqTec



CRT

Multistage centrifugal pumps

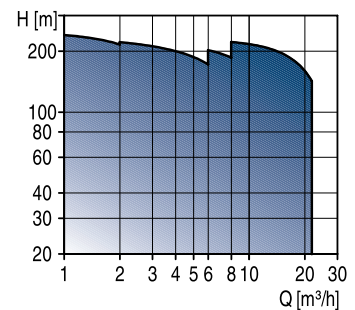

Technical data

Flow, Q:	max. 26 m ³ /h
Head, H:	max. 270 m
Liquid temp.:	- 20°C to +120°C
Operat. pres.:	max. 25 bar

Applications

The pumps are suitable for liquid transfer in

- Process water systems
- Washing in cleaning systems
- Sea water systems
- Pumping of acids and alkalis
- Ultra filtration systems
- Reverse osmosis systems
- Swimming baths

Features and benefits

- High corrosion resistance
- Reliability
- High efficiency
- Service-friendly
- Space-saving

Optional

- Dry-running protection and motor protection via LiqTec

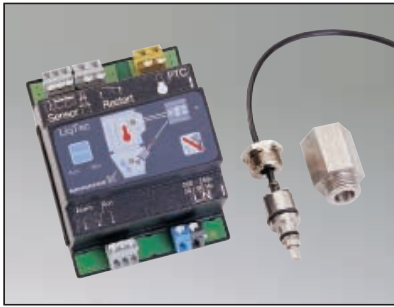

LiqTec

Control and monitoring unit

Applications

- Monitoring and protection of pumps and processes

Features and benefits

- Protection against dry running and too high motor temperatures
- Manual or automatic restarting possible from a remote PC
- Simple installation - plug and play technology
- Robust sensor



CV, CPV, CPH

Multistage centrifugal pumps

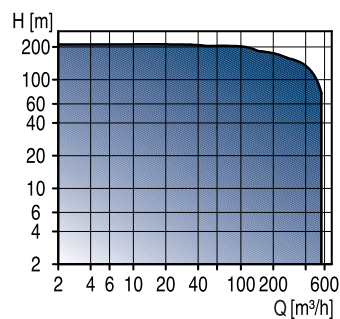

Technical data

Flow, Q:	max. 560 m ³ /h
Head, H:	max. 200 m
Liquid temp.:	- 15°C to +120°C
Operat. pres.:	max. 20 bar

Applications

The pumps are suitable for liquid transfer in

- Washing systems
- Cooling and air-conditioning systems
- Water supply systems
- Water treatment systems
- Fire fighting systems
- Industrial plants
- Boiler feeding systems

Features and benefits

- Low-speed (4-pole motors)
- Heavy-duty
- Low-noise
- Vertical and horizontal installation



CRE, CRIE, CRNE

Multistage centrifugal pumps - electronically controlled

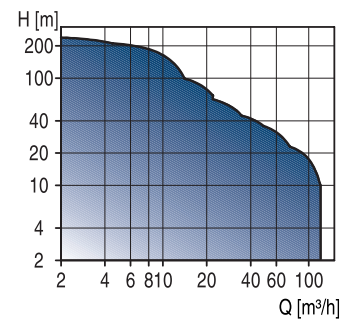

Technical data

Flow, Q:	max. 120 m ³ /h
Head, H:	max. 240 m
Liquid temp.:	- 30°C to +150°C
Operat. pres.:	max. 30 bar

Applications

The pumps are suitable for liquid transfer in

- Washing systems
- Cooling and air-conditioning systems
- Water supply systems
- Water treatment systems
- Fire fighting systems
- Industrial plants
- Boiler feeding systems

Features and benefits

- Wide range
- Reliability
- In-line design
- High efficiency
- Service-friendly
- Space-saving
- Many control facilities

Optional

- Wireless remote control, R100



Hydro 2000, Hydro 1000

Complete pressure boosting systems

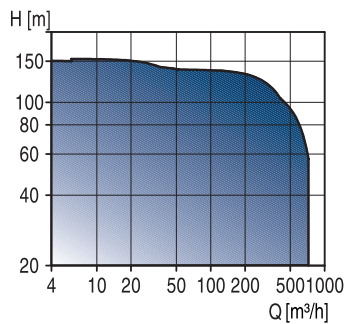

Technical data

Flow, Q:	max. 720 m ³ /h
Head, H:	max. 160 m
Liquid temp.:	0°C to +70°C
Operat. pres.:	max. 16 bar

Applications

Hydro 2000 are suitable for pressure boosting in

- Water supply systems
- Irrigation systems
- Water treatment systems
- Fire fighting systems
- Industrial plants

Features and benefits

- Constant pressure
- Simple installation
- Low-energy
- Wide range

Optional

- External communication, Control 2000



Control 2000

Pump controllers

Applications

Control 2000 is suitable for parallel connection of pumps in

- Water supply systems
- Irrigation systems
- Water treatment systems
- Fire fighting systems
- Industrial plants

Features and benefits

- Complete control panel

Optional

- External communication



BM, BMB

4"-6"-8" booster modules

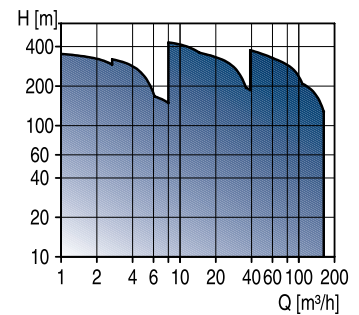

Technical data

Flow, Q:	max. 260 m ³ /h
Head, H:	max. 470 m
Liquid temp.:	0°C to +40°C
Operat. pres.:	max. 80 bar

Applications

The booster modules are suitable for pressure boosting in

- Reverse osmosis systems
- Water supply systems
- Water treatment systems
- Industrial plants

Features and benefits

- Low-noise
- Simple installation
- Modular design
- Compact design
- Leakage-free



BMQ, BMQE-NE

3" booster modules

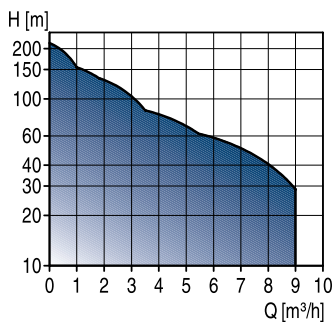

Technical data

Flow, Q:	max. 9 m³/h
Head, H:	max. 215 m
Liquid temp.:	0°C to +40°C
Operat. pres.:	max. 30 bar

Applications

The booster modules are suitable for pressure boosting in

- Reverse osmosis systems
- Water supply systems
- Water treatment systems
- Industrial plants

Features and benefits

- Simple installation
- Modular design
- Compact design
- Integrated dry-running protection
- Soft start
- Over- and undervoltage protection

Optional

- BMQE-NE can be protected, monitored and controlled via CU 300/R100

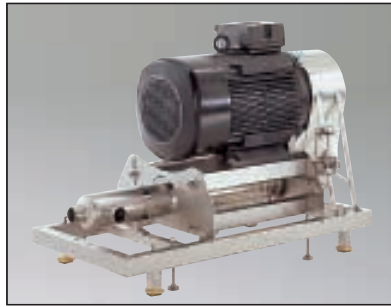

BME, BMET

High-pressure booster systems

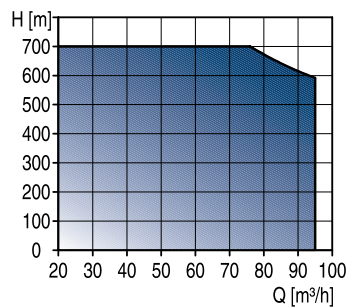

Technical data

Flow, Q:	max. 95 m³/h
Head, H:	max. 700 m
Liquid temp.:	0°C to +40°C
Operat. pres.:	max. 70 bar

Applications

The booster systems are suitable for pressure boosting in

- Reverse osmosis systems
- Water supply systems
- Water treatment systems
- Industrial plants

Features and benefits

- High-pressure/high-flow
- Low-energy
- Simple installation
- Compact design

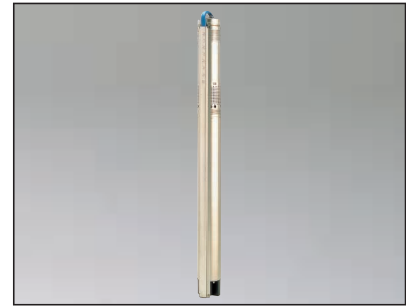

SQ, SQE

3" submersible pumps

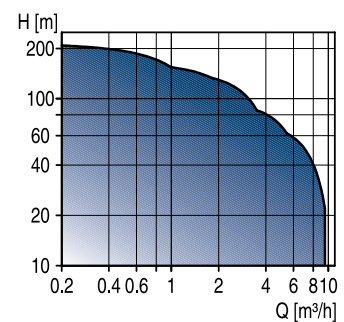

Technical data

Flow, Q:	max. 10 m³/h
Head, H:	max. 215 m
Liquid temp.:	0°C to +40°C
Instal. depth:	max. 150 m

Applications

The pumps are suitable for

- Domestic water supply
- Groundwater supply to waterworks
- Irrigation in horticulture and agriculture
- Groundwater lowering
- Industrial applications

Features and benefits

- Integrated dry-running protection
- Soft start
- Over- and undervoltage protection
- High efficiency

Optional

- SQE can be protected, monitored and controlled via CU 300/R100

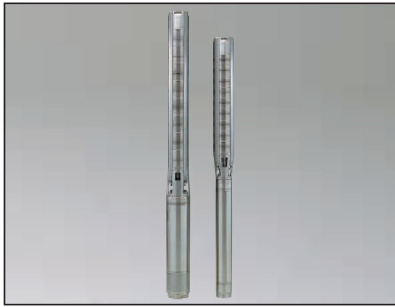

SP A, SP, SP-G

4"-6"-8"-10"-12" submersible pumps

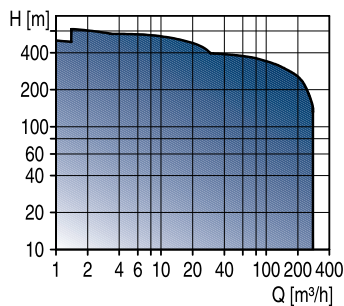

Technical data

Flow, Q: max. 470 m³/h
 Head, H: max. 650 m
 Liquid temp.: 0°C to +60°C
 Instal. depth: max. 600 m

Applications

- The pumps are suitable for
- Groundwater supply to waterworks
 - Irrigation in horticulture and agriculture
 - Groundwater lowering
 - Pressure boosting
 - Industrial applications

Features and benefits

- High efficiency
- Long service life as all components are stainless steel
- Motor protection via CU 3

Optional

- Data can be monitored and controlled via CU 3/R100



MS motors

Stainless steel 4" and 6" submersible motors.

Motor sizes

4" motor: 0.37 to 7.5 kW
 6" motor: 5.5 to 30 kW

Applications

The Grundfos MS submersible motors can be fitted on all Grundfos SP A, SP pumps and can be used in the high-pressure booster modules, type BM and BMB.

Features and benefits

- Overprotection by means of a built-in Tempcon temperature transmitter
- Standardized NEMA head and shaft end
- Completely encapsulated in stainless steel
- Liquid cooled and has liquid lubricated bearings

Optional

- Material variants available



MMS motors

Stainless steel 6",8",10",12" rewindable submersible motors.

Motor sizes

6" motor: 3.7 to 37 kW
 8" motor: 22 to 110 kW
 10" motor: 75 to 190 kW
 12" motor: 147 to 250 kW

Applications

The Grundfos MMS submersible motors can be fitted on all Grundfos SP and SP-G pumps.

Features and benefits

- Wide range of rewindable motors
- Easily rewinded
- Protection against upthrust
- High efficiency
- 6" and 8" have standardized NEMA head and shaft end

Optional

- Material variants available
- PA windings
- Mechanical shaft seal SiC/SiC
- Overtemperature protection via Pt100



SQE-NE, SP-NE

Environmental pumps

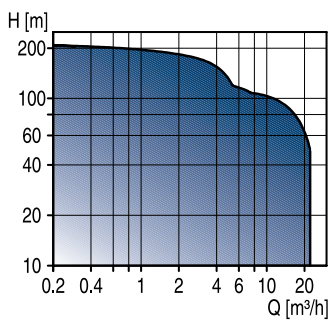

Technical data

Flow, Q: max. 22 m³/h
 Head, H: max. 215 m
 Liquid temp.: 0°C to +40°C
 Instal. depth: max. 600 m

Applications

The pumps are suitable for

- Pumping up contaminated groundwater
- Sampling
- Remedial pumping

Features and benefits

SQE-NE

- Same features and benefits as SQE

SP-NE

- Same features and benefits as SP



MP 1

Environmental pumps

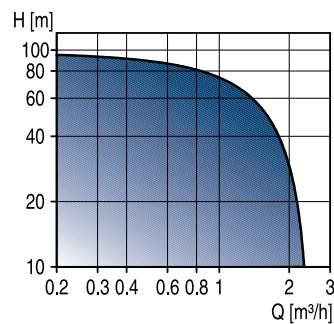

Technical data

Flow, Q: max. 2.4 m³/h
 Head, H: max. 95 m
 Liquid temp.: 0°C to +35°C

Applications

The pumps are suitable for

- Sampling

Features and benefits

- Compact design
- Fit into 50 mm boreholes



Solar systems

Solar powered submersible pumps

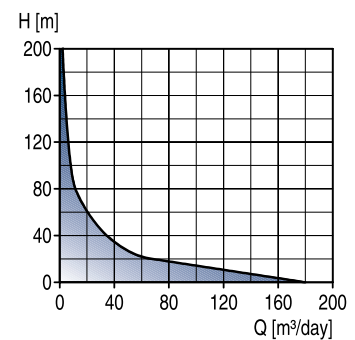

Technical data

Flow, Q: max. 180 m³/day
 Head, H: max. 200 m
 Liquid temp.: max. +40°C

Applications

The solar systems are suitable for

- Water supply and irrigation in locations without electricity supply or where fuel is scarce

Features and benefits

- Requires no electricity supply
- Maintenance-free



CU 3, CU 300, CU 301

Control and monitoring units

Applications

- Monitoring and protection of pump installations

Features and benefits

- Protection against dry running and too high motor temperature
- Constant monitoring of pump energy consumption
- Reading out of operating data via R100

Optional

- Connection to large control systems via bus-communication
- Connection of sensors enabling control based on sensor signals



JP

Self-priming jet pumps

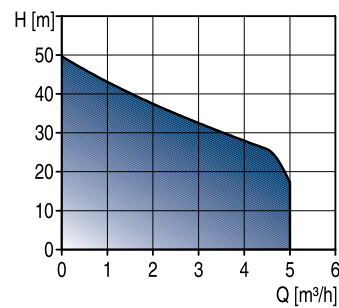

Technical data

Flow, Q:	max. 5 m³/h
Head, H:	max. 48 m
Liquid temp.:	0°C to +55°C
Operat. pres.:	max. 6 bar

Applications

The pumps are suitable for liquid transfer in

- Households
- Gardens
- Hobby activities
- Agriculture
- Horticulture
- Small industries

Features and benefits

- Self-priming
- Stable operation even in case of air pockets in the liquid

Optional

- Automatic start/stop when equipped with Presscontrol
- Booster sets for small-scale water supply

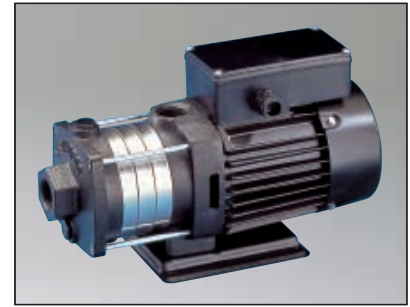

CH, CHN

Multistage centrifugal pumps

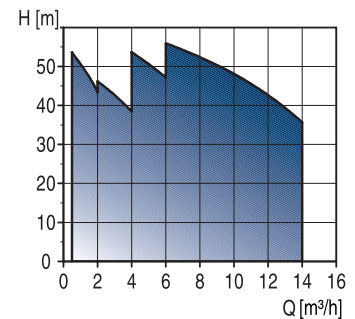

Technical data

Flow, Q:	max. 14 m³/h
Head, H:	max. 55 m
Liquid temp.:	0°C to +90°C
Operat. pres.:	max. 10 bar

Applications

The pumps are suitable for liquid transfer in

- Pressure boosting
- Domestic water supply
- Cooling systems
- Air-conditioning systems
- Horticultural irrigation
- Small industrial water supply systems

Features and benefits

- Compact design
- Robust design
- Full stainless steel design (CHN only)
- Low noise

Optional

- Booster sets for domestic water supply
- Automatic start/stop when equipped with Presscontrol



MQ

Multistage centrifugal self-priming pumps

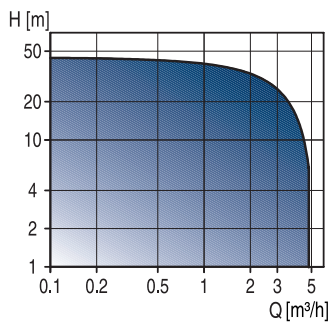

Technical data

Flow, Q:	max. 5 m ³ /h
Head, H:	max. 48 m
Liquid temp.:	0°C to +35°C
Operat. pres.:	max. 7.5 bar

Applications

- The pumps are suitable for liquid transfer in
- Private homes
 - Holiday cottages
 - Farms
 - Green houses

Features and benefits

- All-in-one pressure booster unit
- Easy to install
- Easy to operate
- Self-priming
- Dry-running protection with automatic reset
- Low noise
- Maintenance free



CHV

Multistage centrifugal pumps

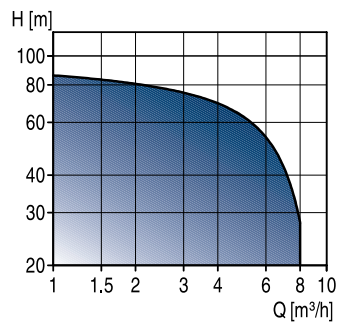

Technical data

Flow, Q:	max. 8 m ³ /h
Head, H:	max. 93 m
Liquid temp.:	0°C to +90°C
Operat. pres.:	max. 12 bar

Applications

- The pumps are suitable for liquid transfer in
- Pressure boosting
 - Domestic water supply
 - Cooling systems
 - Air-conditioning systems
 - Horticultural irrigation
 - Small industrial water supply systems

Features and benefits

- Compact design
- Robust design
- Low noise
- Space-saving



CHV booster

Vertical pressure booster systems

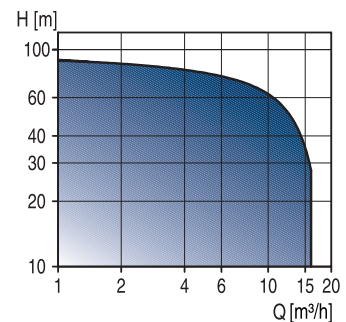

Technical data

Flow, Q:	max. 16 m ³ /h
Head, H:	max. 93 m
Liquid temp.:	0°C to +40°C
Operat. pres.:	max. 10 bar

Applications

- The booster systems are suitable for pressure boosting in
- Small waterworks
 - Small blocks of flats
 - Hotels
 - Stores
 - Light industry
 - Hospitals
 - Schools
 - Large houses

Features and benefits

- One- or two-pump system
- User-friendly controllers
- Reliability
- High efficiency
- Service-friendly

Optional

- Overpressure protection
- Dry-running protection



Tanks

Diaphragm and bladder tanks

Technical data

Tank size: 19-1000 l
 Liquid temp.: max. +70°C
 Operat. pres.: max. 7 bar

Applications

The diaphragm and bladder tanks are used in

- Water supply systems in housing
- Pressure boosting systems in housing
- Agriculture
- Horticulture
- Industrial systems

Features and benefits

- Optimal water supply
- Reduced number of pump starts
- Ideal for drinking water



KP, AP, AP35B, AP50B - stainless steel

Drainage pumps

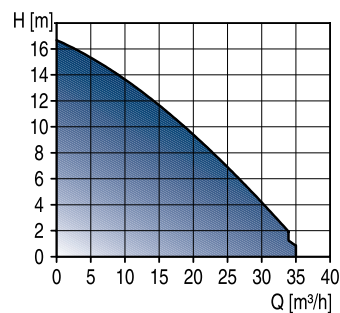

Technical data

Flow, Q: max. 35 m³/h
 Head, H: max. 18 m
 Liquid temp.: 0°C to +55°C
 Particle size: max. ø50 mm

Applications

The pumps are suitable for

- Drainage of flooded cellars
- Pumping of household wastewater
- Groundwater lowering
- Emptying of swimming pools and excavations
- Drainage of drain wells
- Emptying of tanks and reservoirs

Features and benefits

- Simple installation
- Service- and maintenance-free

Optional

- AP35B and AP50B are suitable for installation on auto-coupling



AP, APG - cast iron

Effluent and sewage pumps

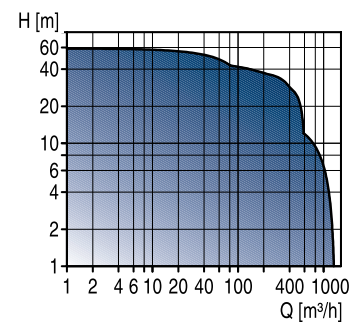

Technical data

Flow, Q: max. 1320 m³/h
 Head, H: max. 67 m
 Liquid temp.: 0°C to +40°C
 Particle size: max. ø130 mm

Applications

The pumps are suitable for

- Pumping large quantities of effluent and sewage water
- Liquid transfer in general

Features and benefits

- Wide range
- Service-friendly
- Wide field of applications
- Various types of impellers

Optional

- Various fittings
- Controllers for level control monitoring and protection of the pumps.



APB

Contractor pumps

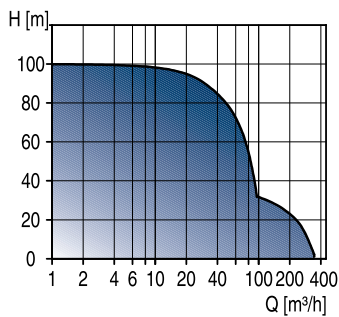

Technical data

Flow, Q: max. 360 m³/h
 Head, H: max. 100 m
 Liquid temp.: 0°C to +40°C

Applications

The pumps are suitable for liquid transfer in

- Tunnels
- Mines
- Quarries
- Gravel pits
- Fish ponds
- Building sites

Features and benefits

- Extremely hard-wearing due to specially selected materials
- Simple installation
- Service-friendly



Lifting stations

Complete pumping stations

Applications

The lifting stations are suitable for use in

- Single- and multi-family houses
- Weekend cottages and summer houses
- Restaurants
- Small hotels
- Sewage systems in the open country
- Percolation systems

Features and benefits

- Ready for installation
- Maintenance-free
- Flexible pipe connection



Grundfos Sarlin S pumps

Supervortex pumps, single- or multi-channel impeller pumps

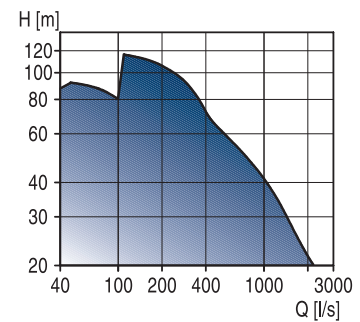

Technical data

Flow, Q: max. 2400 l/s
 (8640 m³/h)
 Head, H: max. 115 m
 Liquid temp.: 0°C to +40°C
 Frame size, DN: from DN 80 to DN 800

Applications

The pumps are suitable for the following applications

- Transfer of wastewater
- Transfer of raw water
- Pumping of sludge-containing water
- Pumping of industrial effluent

Features and benefits

- Wide range
- SmartTrim
- Installation on stand or base plate
- Operation with/without cooling jacket
- Submerged or dry installation
- Different types of impellers
- Built-in motor protection

Options

- Control and protection systems



Grundfos Sarlin SA pumps

Submersible, axial-flow pumps

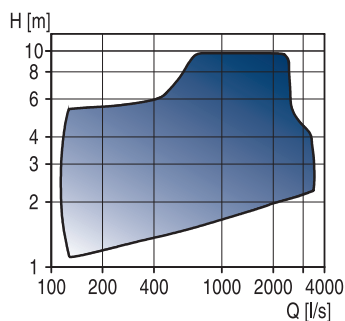

Technical data

Flow, Q:	max. 3500 l/s (12600 m ³ /h)
Head, H:	max. 9 m
Liquid temp.:	0°C to +40°C
Column pipe diameter:	700 to 1400 mm

Applications

The pumps are suitable for the following applications

- Transfer of raw water
- Pumping of water from sewage treatment plants
- Storm water pumping
- Irrigation
- Pumping of water in marine installations
- Industrial applications

Features and benefits

- High efficiency stainless steel propeller
- Totally submerged installations
- Built-in motor protection
- Flexibility of installation

Options

- Control and protection systems
- Motor operation control

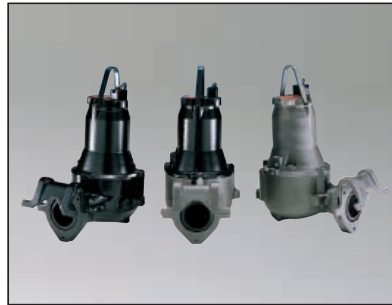

Grundfos Sarlin Stainless steel pumps

Submersible stainless steel pumps

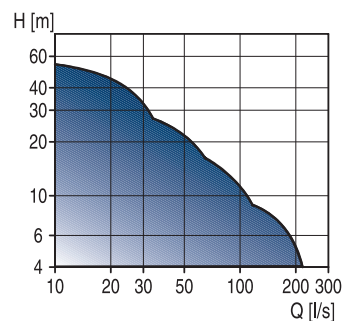

Technical data

Flow, Q:	max. 217 l/s (781 m ³ /h)
Head, H:	max. 53 m
Liquid temp.:	0°C to +40°C
Diameter:	DN 80 to DN 250

Applications

The pumps are suitable for the following applications

- Transfer of wastewater and raw water
- Pumping of
 - highly corrosive liquids
 - salty water / wastewater
 - water from chemical industries
 - industrial process liquids
- Pulp and paper industries

Features and benefits

- Installation on stand or base plate
- Different types of impellers
- Built-in motor protection
- Various executions in stainless steel
- Water with pH values less than 4 and above 10

Optional

- External cooling water
- External seal flush system

Denmark

GRUNDFOS DK A/S
Poul Due Jensens Vej 7A
DK-8850 Bjerringbro
Tlf.: +45-87 50 50 50
Telefax: +45-87 50 51 51

Argentina

Bombas GRUNDFOS de Argentina S.A.
Ruta Panamericana km. 37.500 Lote 34A
1619 - Garin
Pcia. de Buenos Aires
Phone: +54-3327 414 444
Telefax: +54-3327 411 111

Australia

GRUNDFOS Pumps Pty. Ltd.
P.O. Box 2040
Regency Park
South Australia 5942
Phone: +61-8-8461-4611
Telefax: +61-8-8340 0155

Austria

GRUNDFOS Pumpen Vertrieb Ges.m.b.H.
Grundfosstraße 2
A-5082 Grödig/Salzburg
Tel.: +43-6246-883-0
Telefax: +43-6246-883-30

Belgium

N.V. GRUNDFOS Bellux S.A.
Boomssesteenweg 81-83
B-2630 Aartselaar
Tél.: +32-3-870 7300
Télécopie: +32-3-870 7301

Brazil

GRUNDFOS do Brasil Ltda.
Rua Tomazina 106
CEP 83325-040
Pinhais - PR
Phone: +55-41 668 3555
Telefax: +55-41 668 3554

Canada

GRUNDFOS Canada Inc.
2941 Brighton Road
Oakville, Ontario
L6H 6C9
Phone: +1-905 829 9533
Telefax: +1-905 829 9512

China

GRUNDFOS Pumps (Shanghai) Co. Ltd.
22 Floor, Xin Hua Lian Building
755-775 Huai Hai Rd, (M)
Shanghai 200020
PRC
Phone: +86-21-64 67 28 09
Telefax: +86-21-64 67 28 08

Czech Republic

GRUNDFOS s.r.o.
Cajkovského 21
779 00 Olomouc
Phone: +420-68-5716 111
Telefax: +420-68-543 8908

Finland

OY GRUNDFOS Pumput AB
Mestarintie 11
Piispankylä
FIN-01730 Vantaa (Helsinki)
Phone: +358-9 878 9150
Telefax: +358-9 878 91550

France

Pompes GRUNDFOS Distribution S.A.
Parc d'Activités de Chesnes
57, rue de Malacombe
F-38290 St. Quentin Fallavier (Lyon)
Tél.: +33-4 74 82 15 15
Télécopie: +33-4 74 94 10 51

Germany

GRUNDFOS GMBH
Delta Haus
Schlüterstr. 33, 40699 Erkrath
Tel.: +49-211-9296-0
Telefax: +49-9296 531

Greece

GRUNDFOS Hellas A.E.B.E.
20th km. Athinon-Markopoulou Av.
P.O. Box 71
GR-19002 Peania
Phone: +30-1-66 83 400
Telefax: +30-1-6646273

Hong Kong

GRUNDFOS Pumps (Hong Kong) Ltd.
Unit 1, Ground floor
Siu Wai Industrial Centre
29-33 Wing Hong Street &
68 King Lam Street, Cheung Sha Wan
Kowloon
Phone: +852-27861706/27861741
Telefax: +852-27858664

Hungary

GRUNDFOS Hungária Kft.
Park u. 8
H-2045 Törökbalint,
Phone: +36-23 511 110
Telefax: +36-23 511 111

India

GRUNDFOS Pumps India Private Limited
Flat A, Ground Floor
61/62 Chamiers Aptmt
Chamiers Road
Chennai 600 028
Phone: +91-44 432 3487
Telefax: +91-44 432 3489

Indonesia

PT GRUNDFOS Pompa
Jl. Rawa Sumur III, Blok III / CC-1
Kawasan Industri, Pulogadung
Jakarta 13930
Phone: +62-21-460 6909
Telefax: +62-21-460 6910/460 6901

Ireland

GRUNDFOS (Ireland) Ltd.
Unit 34, Stillorgan Industrial Park
Blackrock
County Dublin
Phone: +353-1-2954926
Telefax: +353-1-2954739

Italy

GRUNDFOS Pompe Italia S.r.l.
Via Gran Sasso 4
I-20060 Truccazzano (Milano)
Tel.: +39-02-95838112/95838212
Telefax: +39-02-95309290/95838461

Japan

GRUNDFOS Pumps K.K.
1-2-3, Shin Miyakoda
Hamamatsu City
Shizuoka pref. 431-21
Phone: +81-53-428 4760
Telefax: +81-53-484 1014

Korea

GRUNDFOS Pumps Korea Ltd.
2nd Fl., Dong Shin Building
994-3 Daechi-dong, Kangnam-Ku
Seoul 135-280
Phone: +82-2-5317 600
Telefax: +82-2-5633 725

Malaysia

GRUNDFOS Pumps Sdn. Bhd.
7 Jalan Peguam U1/25
Glenmarie Industrial Park
40150 Shah Alam
Selangor
Phone: +60-3-5569 2922
Telefax: +60-3-5569 2866

Mexico

Bombas GRUNDFOS de Mexico S.A. de C.V.
Boulevard TLC No. 15
Parque Industrial Stiva Aeropuerto
Apodaca, N.L. 66600
Mexico
Phone: +52-8-144 4000
Telefax: +52-8-144 4010

Netherlands

GRUNDFOS Nederland B.V.
Pampuslaan 190
NL-1382 JS Weesp
Tel.: +31-294-492 211
Telefax: +31-294-492244/492299

New Zealand

GRUNDFOS Pumps NZ Ltd.
17 Beatrice Tinsley Crescent
North Harbour Industrial Estate
Albany, Auckland
Phone: +64-9-415 3240
Telefax: +64-9-415 3250

Norway

GRUNDFOS Pumper A/S
Strømsveien 344
Postboks 235, Leirdal
N-1011 Oslo
Tlf.: +47-22 90 47 00
Telefax: +47-22 32 21 50

Poland

GRUNDFOS Pompy Sp. z o.o.
ul. Klonowa 23
Baranowo k. Poznania
PL-62-081 Przewmierowo
Phone: +48-61-650 13 00
Telefax: +48-61-650 13 50

Portugal

Bombas GRUNDFOS Portugal, S.A.
Rua Calvet de Magalhães, 241
Apartado 1079
P-2780 Paço de Arcos
Tel.: +351-21-440 76 00
Telefax: +351-21-440 76 90

Russia

OOO GRUNDFOS- Service Center
Shkolnaya, ul., 39
RUS-109544 Moscow
Phone: +7-095 271 00 00
Telefax: +7-095 271 09 39

Singapore

GRUNDFOS (Singapore) Pte. Ltd.
24 Tuas West Road
Jurong Town
Singapore 638381
Phone: +65-865 1222
Telefax: +65-861 8402

Spain

Bombas GRUNDFOS España S.A.
Camino de la Fuentevilla, s/n
E-28110 Algete (Madrid)
Tel.: +34-91-848 8800
Telefax: +34-91-628 0465

Sweden

GRUNDFOS AB
Box 63, Angeredsvinkeln 9
S-424 22 Angered
Tel.: +46-771-32 23 00
Telefax: +46-31 331 94 60

Switzerland

GRUNDFOS Pumpen AG
Bruggacherstrasse 10
CH-8117 Fällanden/ZH
Tel.: +41-1-806 8111
Telefax: +41-1-806 8115

Taiwan

GRUNDFOS Pumps (Taiwan) Ltd.
14, Min-Yu Road
Tunglo Industrial Park
Tunglo, Miae-Li County
Taiwan, R.O.C.
Phone: +886-37-98 05 57
Telefax: +886-37-98 05 70

Thailand

GRUNDFOS (Thailand) Ltd.
947/168 Moo 12, Bangna-Trad Rd., K.M. 3,
Bangna, Phrakonong
Bangkok 10260
Phone: +66-2-744 1785 ... 91
Telefax: +66-2-744 1775 ... 6

Turkey

GRUNDFOS POMPA SAN. ve TIC. LTD. STI
Bulgurlu Caddesi no. 32
TR-81190 Üsküdar Istanbul
Phone: +90 - 216-4280 306
Telefax: +90 - 216-3279 888

United Arab Emirates

GRUNDFOS Gulf Distribution
P.O. Box 16768
Jebel Ali Free Zone
Dubai
Phone: +971-4- 8815 166
Telefax: +971-4-8815 136

United Kingdom

GRUNDFOS Pumps Ltd.
Grovebury Road
Leighton Buzzard/Beds. LU7 8TL
Phone: +44-1525-850000
Telefax: +44-1525-850011

U.S.A.

GRUNDFOS Pumps Corporation
17100 West 118th Terrace
Olathe, Kansas 66061
Phone: +1-913-227-3400
Telefax: +1-913-227-3500